

PGP Polymer Cable Management System

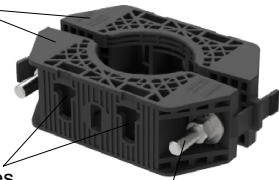

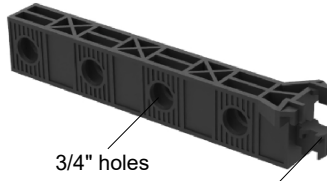

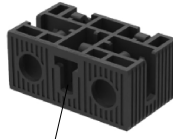

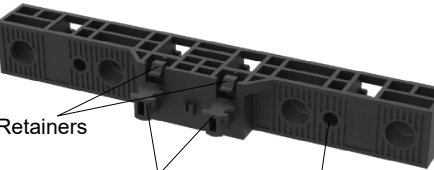
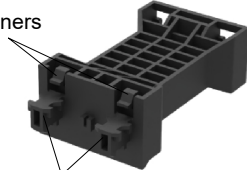





Bulletin 7862015 Revision B Page 1 of 2

Product Parts

 <p>PGCS-1000</p> <p>T-shape holes</p> <p>Hardware kit</p>	<p>PGP-CS02</p> <p>The clamp kit is made from two PGCS-1000 halves plus the necessary hardware kit. Can assembled on 2-3/8" or 2-7/8" pipe with an applied torque of 15 Nm.</p>	<p>NOTE:</p> <ol style="list-style-type: none"> 1. Please use the recommended torque to install the clamp. 2. This product is compatible with both Gen 1 and Gen 2 Snap-In Hangers.
---	--	--

 <p>PGCS-5000</p> <p>3/4" holes</p> <p>T-Connector</p>	 <p>PGCS-6000</p> <p>T-shape hole</p>	 <p>PGCS-7000</p> <p>Retainers</p> <p>T-connectors</p> <p>For 3/8" threaded rod</p>	 <p>PGCS-8000</p> <p>Retainers</p> <p>T-Connectors</p>
---	--	---	---

Recommended Configurations

 <p>PGP-CS04</p>	 <p>PGP-CS08</p>	 <p>PGP-CS10</p>	 <p>PGP-CS12</p>	 <p>PGP-CS16</p>	 <p>PGP-CS18</p>
 <p>PGP-CS10-R</p>	 <p>PGP-CS16L</p>	 <p>PGP-CS18L</p>	 <p>PGP-CS34L</p>	 <p>PGP-CS36</p>	
 <p>PGP-CS20-R</p>	 <p>PGP-CS38-R</p>	<p>NOTE:</p> <ol style="list-style-type: none"> 1. Intended for Jumper Cable use only. 2. Two cable hangers per 3/4" hole position, except PGP-CS20-R and PGP-CS38-R, which are limited to one cable hanger per 3/4" hole position. 3. PGP-CS12 can only be used on 2-7/8" pipes 			

PGP Polymer Cable Management System

Bulletin 7862015 Revision B Page 2 of 2

Install on 2-3/8" pipe

First install the components on the both sides of the clamp (PGCS-1000), then install the two assembled clamps to the 2-3/8" pipe.

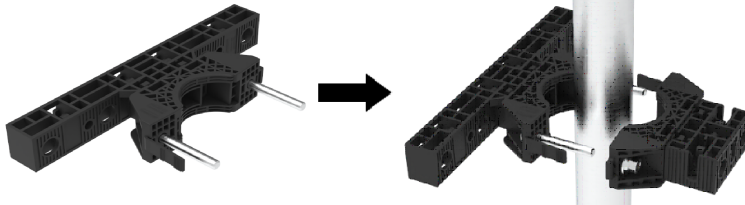

Install on 2-7/8" pipe

First use bolts to install two PGCS-1000s on the 2-7/8" pipe, and then install the required components according to the configuration.

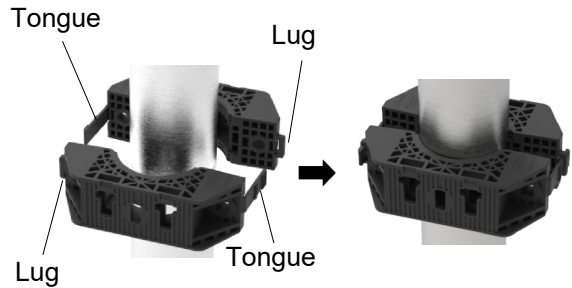
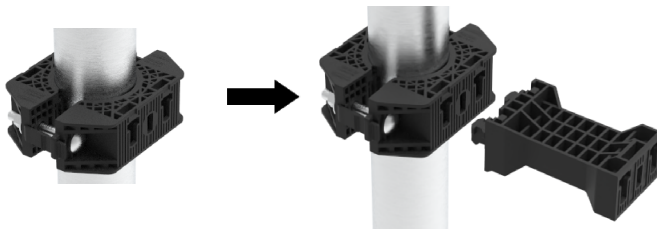

Installation of Clamp: Fix clamp to the pipe, then insert the tongues on both sides of the clamp into the corresponding lugs.

Disassembly of Clamp: Hold the tongues on both sides of the clamp. Use both hands to pull the clamp halves apart by removing the tongue from the lug.

WARNING

Do not tighten the clamp directly on the 2-3/8" pipe with bolts to prevent the clamp from deforming and making it impossible to install other components.

Installation of wedges: Fully insert the T-Connectors into the T-shape holes, slide the T-Connectors down, until you hear a "click" to indicate that the installation is complete.

Disassembly of wedges:

1

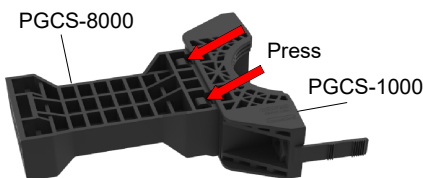

Press the arrow position with fingers to push back the retainers, until these retainers are back against the mounting surface, to allow the T-Connectors to release.

2

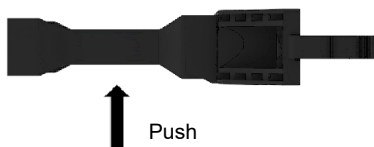

Hold the PGCS-1000, push out the PGCS-8000 as shown in the figure, and then pull it out to complete the disassembly.

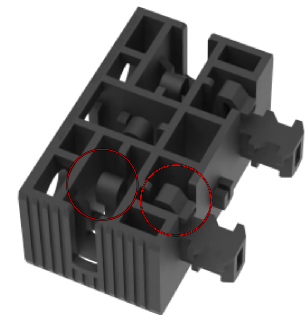

NOTE:
The same or similar retainer structure can be disassembled as shown on the left.