

REVISIONS			
REV.	DESCRIPTION	BY	DATE
A	INITIAL RELEASE	MJP	11/17/23

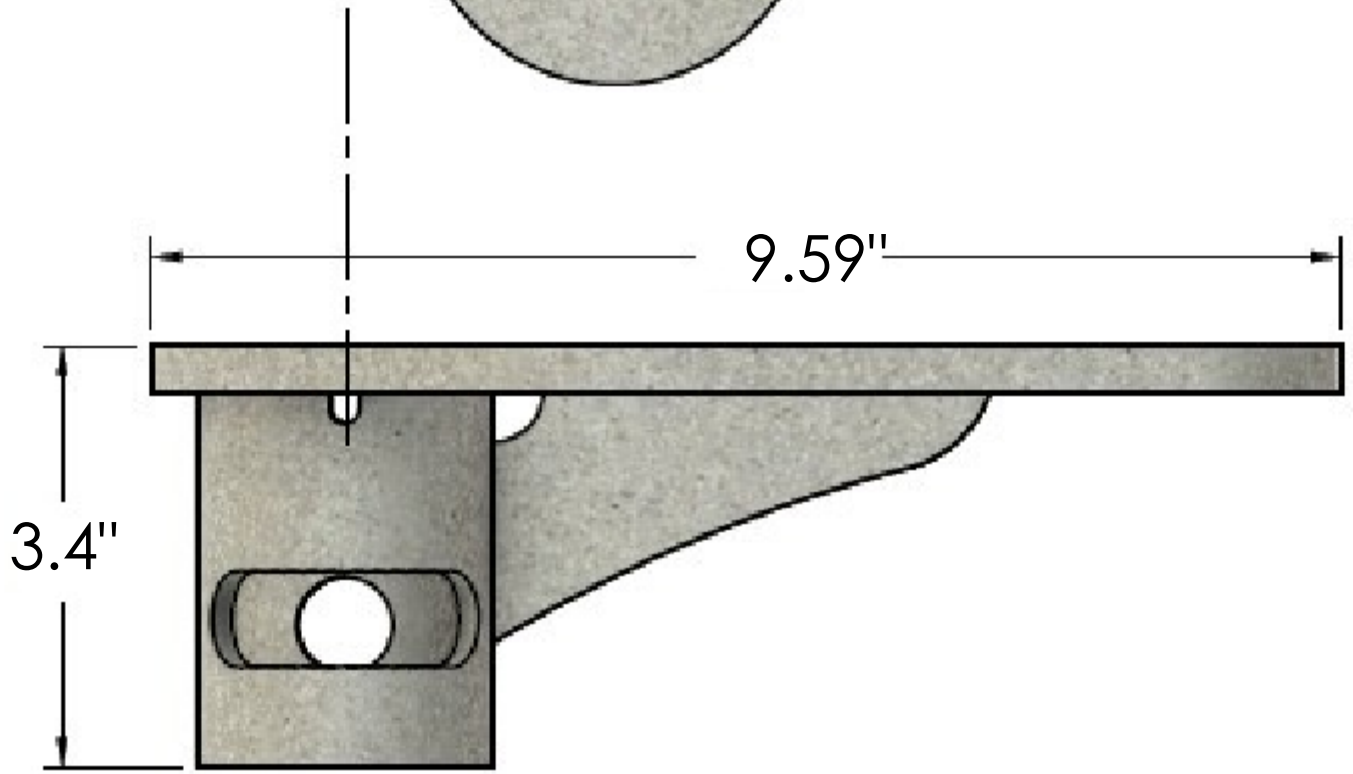
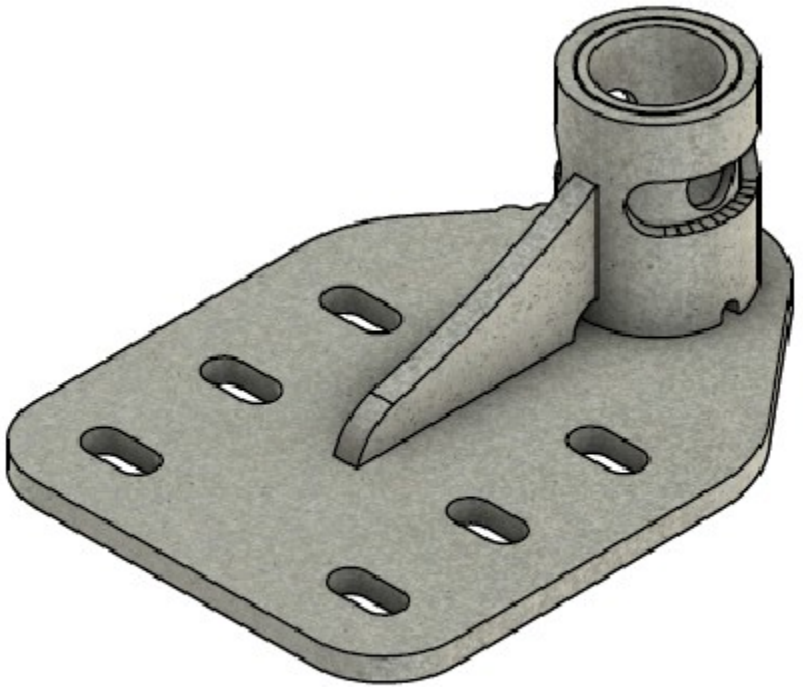
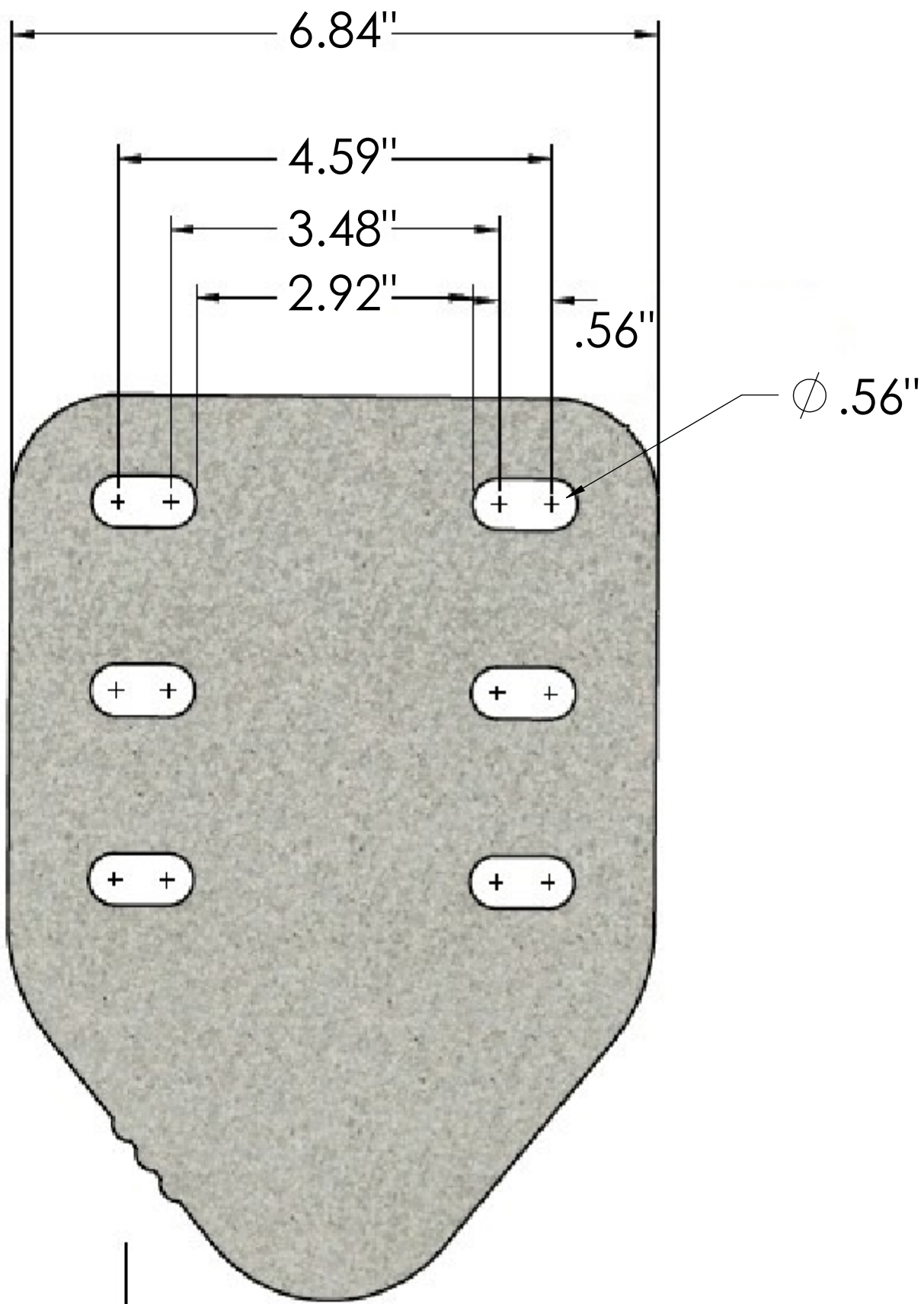

TOLERANCES		SAP MATERIAL MASTER	
1 PLACE .X ± SEE NOTE 1 3 PLACE .XXX ±			
2 PLACE .XX ±		ANGLES ±	
FINISH		MATERIAL	
UNLESS OTHERWISE SPECIFIED DIMENSIONS ARE IN INCHES INTERPRET PER ANSI Y 14.5M-1994		TITLE	
CE	NAME	DATE	U-MF-KB-DBOARD-PLL-3T4
RW			
AD			
RE			
ECN			
SCALE		DOCUMENT NO.	
1:42		U-MF-KB-DBOARD-PLL-3T4	
SIZE	Auth Group	MODEL	
C		VERSION	STATUS
		REVISION	REVISION
		DRAWING	
		VERSION	STATUS
		REVISION	REVISION
		SHEET	
		1 OF 1	

DENSITY	lbs/in ³
MASS	lbs
VOLUME	in ³
SURFACE AREA	in ²
HEIGHT	
LENGTH	
WIDTH	