

REVISIONS			
REV.	DESCRIPTION	BY	DATE
A	INITIAL RELEASE	MJP	11/17/23

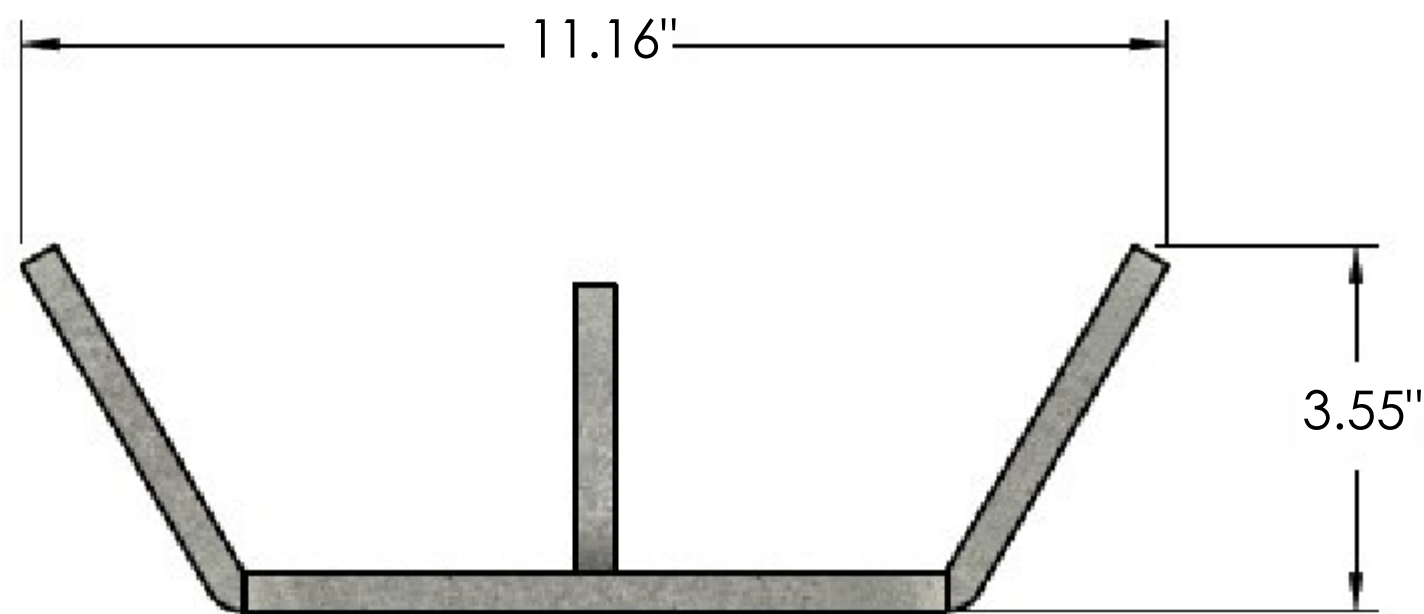
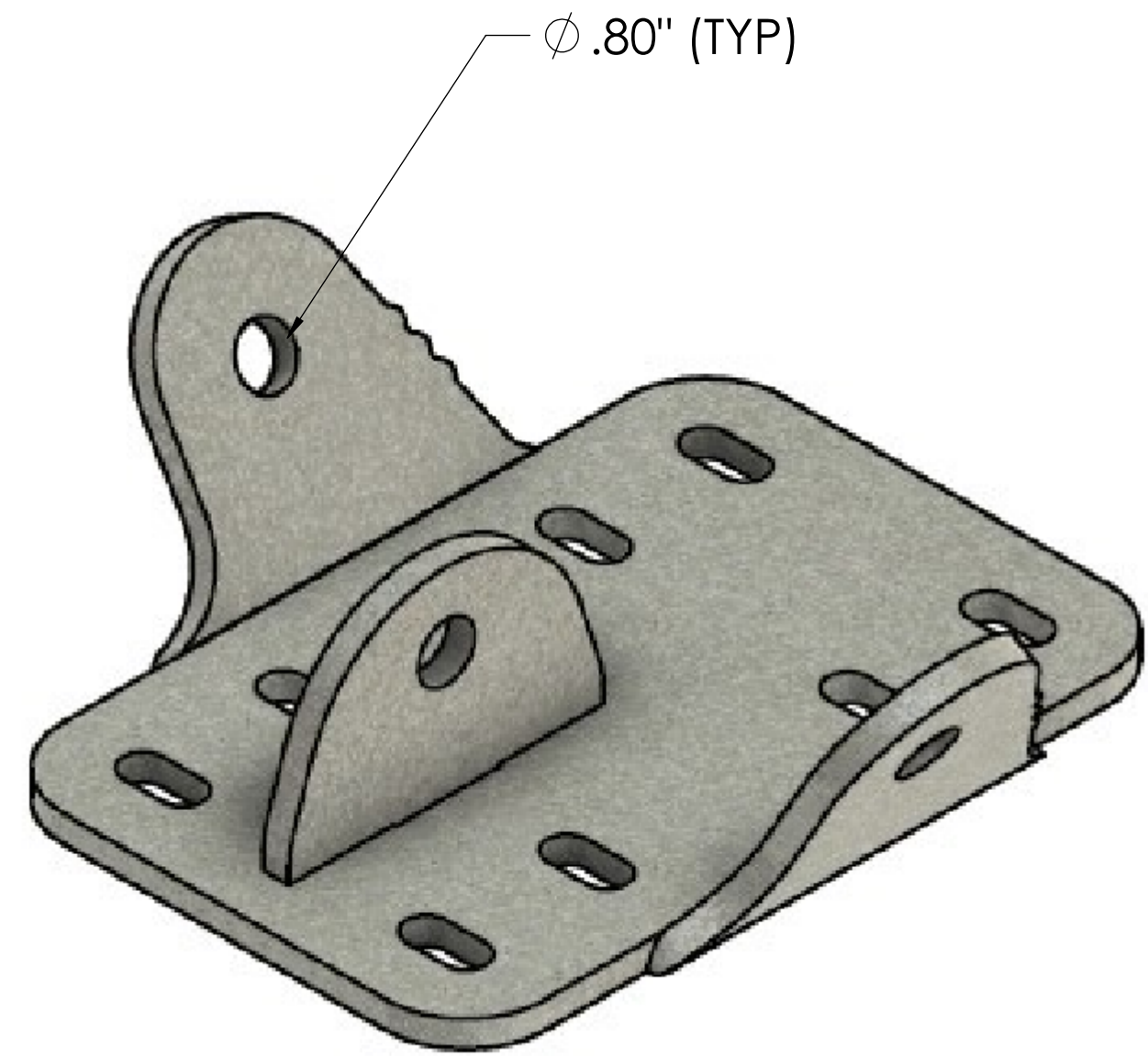
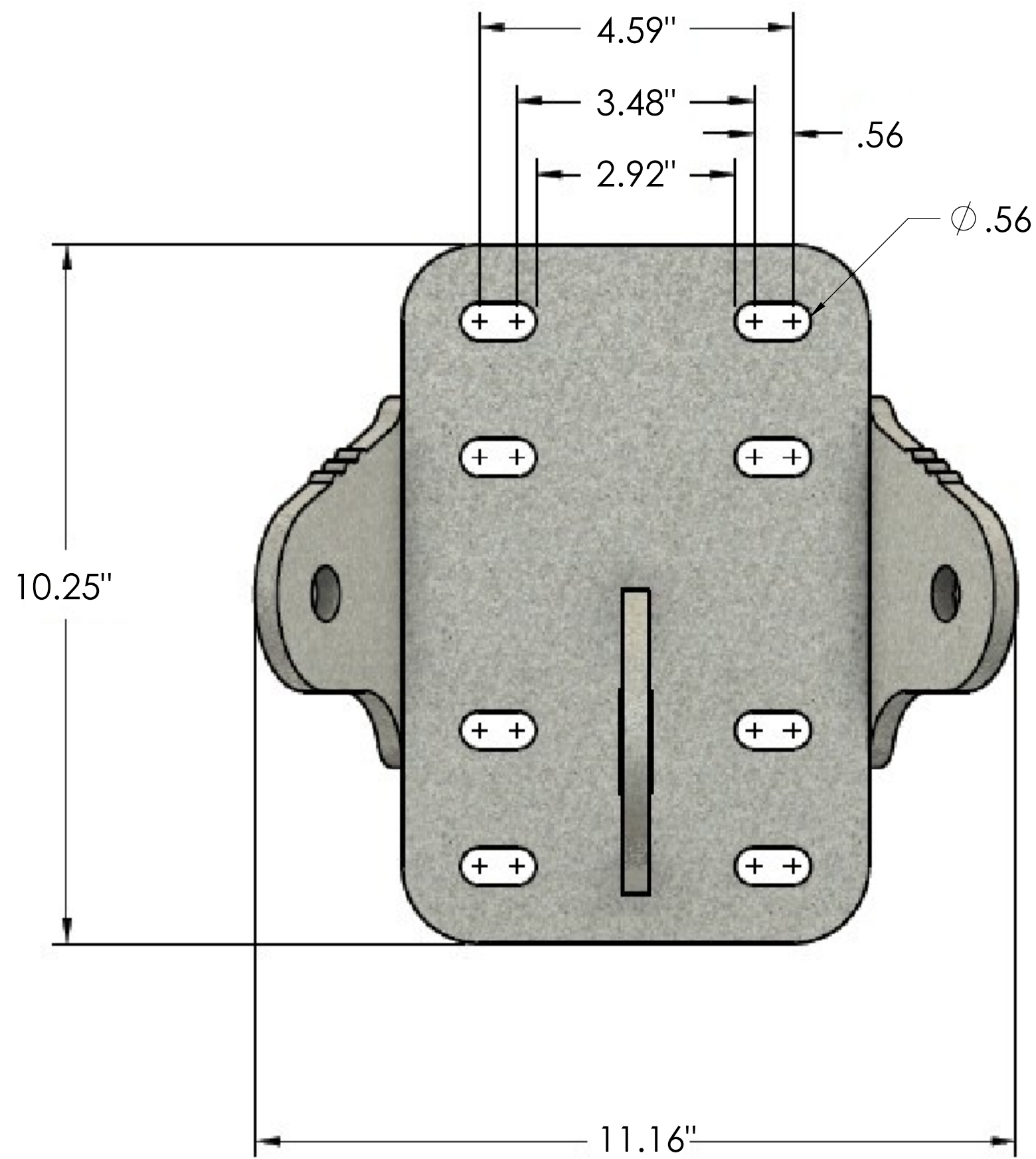

1 PLACE .X ± SEE NOTE 1		3 PLACE .XXX ±		SAP MATERIAL MASTER		
2 PLACE .XX ±		ANGLES ±		FINISH		
FINISH		MATERIAL				
UNLESS OTHERWISE SPECIFIED DIMENSIONS ARE IN INCHES INTERPRET PER ANSI Y 14.5M-1994	NAME	DATE	TITLE			
	CE		U-BLADE-PLL-3T4-60			
	RW		SCALE	DOCUMENT NO.		
	AD		1:42	UBPPL-3T4-60		
	RE					
ECN	Auth Group		MODEL		DRAWING	
SIZE	C	VERSION	STATUS	REVISION	VERSION	STATUS
HEIGHT						
LENGTH						
WIDTH						
SHEET 1 OF 1						

DENSITY	lbs/in ³
MASS	lbs
VOLUME	in ³
SURFACE AREA	in ²